



# AILONG METAL PRODUCTS

**杭州爱龙金属制品有限公司**

HANGZHOU AILONG METAL PRODUCTS CO.,LTD.

地址: 浙江省杭州市萧山区临浦工业区临复路3号

ADD: Linfu Road 3# Linpu Industrial Zone,  
Xiaoshan, hangzhou, zhejiang, china

Mobile: 86-13732263689

86-13806506219 (ALLEN)

Fax:86-571-82460090

E-mail: allen@ailongmetal.com

Website: www.ailongmetal.com

P.C.: 311251

**杭州爱龙金属制品有限公司**

HANGZHOU AILONG METAL PRODUCTS CO.,LTD.



[www.ailongmetal.com](http://www.ailongmetal.com)

# Introduction

Ailong is founded in early 90's as a local workshop in Hangzhou for producing construction stamping parts. Through years of partnership with Tatsumi Corporation, a world class leading construction Corporation, we have gradually built up a solid foundation of R & D and manufacturing capabilities of metal reinforcement fittings for timber construction as well as to provide strength and stability against Earthquakes. Ailong's involvement begins with the earliest phase in the creation of new generations of products and continuous dialogue with customers throughout design and development stage.

Over the years, the ever growing customer based and shared know-how has taken us one step forward, our customers are no longer limited to core expertise. We are also supplying components to customers from various installation and fixation applications such as tarpaulin structure, security fencing, animal husbandry production and ventilation and power supply network , etc. Our workshop covers 53,000 square meters, equipped with advanced precise production and testing equipments. With the backup of our solid manufacturing capabilities and years of experience in parts design and production, our R & D teams and engineers will help your business grow by concentrating your resources to increase productivity at decreased costs.

# IMPACT SOCKET

CR  
MO



## 1/4"Dr. Impact Socket

Size mm	Size inch	L mm	D1 Max mm	D2 Max mm	
4	5/32	25	6.8	13.8	40
4.5	*	25	7.2	13.8	40
5	3/16	25	8	13.8	40
5.5	7/32	25	8.5	13.8	40
6	1/4	25	9.2	13.8	40
6.5	*	25	9.2	13.8	40
7	9/32	25	10.8	13.8	40
8	5/16	25	11.8	13.8	40
9	11/32	25	12.8	13.8	32
10	3/8	25	13.8	14.8	24
11	7/16	25	13.8	15.8	22
12	15/32	25	14.7	16.8	20
13	1/2	25	15.7	17.8	15
14	9/16	25	17.3	19.8	15
15	*	25	18.3	20.8	15
16	5/8	25	18.3	20.8	15

## 3/8"Dr. Impact Socket

Size mm	Size inch	L mm	D1 Max mm	D2 Max mm	
6	1/4	32	12	19	30
7	9/32	32	12.6	19	30
8	5/16	32	14	19	30
9	11/32	32	14.5	19	30
10	3/8	32	15.8	19	30
11	7/16	32	16.9	19	30
12	15/36	32	18.2	19	25
13	1/2	32	19.5	22	25
14	9/16	32	20.5	22	20
15	*	32	22	22	20
16	5/8	32	24	22	20
17	11/16	34	25	22	20
18	*	34	26	22	16
19	3/4	34	28	22	16
20	*	34	28	22	12
21	13/16	34	30	22	12
22	7/8	34	32	22	9
23	*	34	32	22	8
24	15/16	34	34	22	8



# IMPACT SOCKET



## 1/2"Dr. Impact Socket

Size mm	Size inch	L mm	D1 Max mm	D2 Max mm		
7	9/32	38	14	24.8	12	216
8	5/16	38	15	24.8	12	216
9	11/32	38	16.3	24.8	12	216
10	3/8	38	17.5	24.8	12	216
11	7/16	38	18	24.8	12	216
12	15/32	38	19	24.8	12	216
13	1/2	38	20	24.8	12	216
14	9/16	38	22	24.8	12	216
15	*	38	23	24.8	12	216
16	5/8	38	24	24.8	12	216
17	11/16	38	26	29.8	12	216
18	*	38	27	29.8	12	216
19	3/4	38	28	29.8	12	216
20	*	38	29	29.8	12	216
21	13/16	38	29.8	29.8	12	216
22	7/8	38	31.8	30	9	162
23	29/32	40	33.8	30	9	162
24	15/16	40	33.8	30	9	162
25	31/32	42	35.8	30	6	108
26	1"	42	35.8	30	5	90
27	1-1/16	42	37.8	30	5	90
28	1-1/8	42	39.8	30		
29	*	42	39.8	30		
30	1-3/16	44	42.8	30.5		
31	*	44	42.8	32.5		
32	1-1/4	44	43.8	32.5		
33	*	48	44.8	32.5		
34	1-5/16	48	46.8	35.8		
35	1-3/8	48	46.8	35.8		
36	1-7/16	48	48.8	36.8		
38	1-1/2	48	49.8	39.8		
41	1-9/16	48	52.8	43.8		
46	*	48	58.8	43.8		



## 3/4"Dr. Impact Socket

Size mm	L mm	D2 Max mm
17	53	44
18	53	44
19	53	44
21	53	44
22	53	44
23	53	44
24	53	44
27	53	44
28	53	44
30	57	44
32	57	44
33	57	44
34	57	44
36	57	44
38	58	44
41	62	44
46	63	44
48	65	44
50	65	54
55	70	54
60	70	54
65	80	54



## 1"Dr. Impact Socket

Size mm	L mm	D2 Max mm
19	58	54
21	58	54
22	58	54
24	58	54
27	58	54
30	62	54
32	62	54
33	62	54
34	62	54
35	62	54
36	65	54
38	65	54
40	65	54
41	70	54
43	70	54
44	70	54
46	75	54
48	75	54
50	75	54
55	83	54
60	87	54
65	90	54
70	93	54
75	95	54

# IMPACT SOCKET

CR  
MO



## 1/4"Dr. Deep Impact Socket

Size mm	Size inch	L mm	D1 Max mm	D2 Max mm	
4	5/32	50	7.2	13.8	40
4.5	*	50	7.2	13.8	40
5	3/16	50	8	13.8	40
5.5	7/32	50	8.5	13.8	40
6	1/4	50	9.2	13.8	40
7	9/32	50	10.8	13.8	40
8	5/16	50	11.8	13.8	40
9	11/32	50	12.8	13.8	40
10	3/8	50	13.8	14.8	24
11	7/16	50	13.8	15.8	22
12	15/32	50	14.7	16.8	20
13	1/2	50	15.7	17.8	15
14	9/16	50	17.3	19.8	15
15	*	50	18.3	20.8	15
16	5/8	50	18.3	20.8	15

# DEEP IMPACT SOCKET

# DEEP IMPACT SOCKET

CR  
MO



## 3/8"Dr. Deep Impact Socket

Size mm	Size inch	L mm	D1 Max mm	D2 Max mm	
6	1/4	65	12	19	30
7	*	65	12.6	19	30
8	5/16	65	14	19	30
9	*	65	14.5	19	30
10	3/8	65	15.8	19	30
11	7/16	65	16.9	19	30
12	*	65	18.2	19	25
13	1/2	65	19.5	22	25
14	9/16	65	20.5	22	20
15	*	65	22	22	20
16	5/8	65	24	22	20
17	11/16	65	25	22	20
18	*	65	26	22	16
19	3/4	65	28	22	16
20	*	65	28	22	12
21	13/16	65	30	22	12
22	7/8	65	32	22	9
23	*	65	32	22	8
24	15/16	65	34	22	8

## 1/2"Dr. Deep Impact Socket

Size mm	Size inch	L mm	D1 Max mm	D2 Max mm		
8	5/16	78	15	24.8	12	144
9	11/32	78	16.3	24.8	12	144
10	3/8	78	17.5	24.8	12	144
11	7/16	78	18	24.8	12	144
12	15/32	78	19	24.8	12	144
13	1/2	78	20	24.8	12	144
14	9/16	78	22	24.8	12	144
15	*	78	23	24.8	12	144
16	5/8	78	24	24.8	12	144
17	11/16	78	26	29.8	12	144
18	*	78	27	29.8	12	144
19	3/4	78	28	29.8	12	144
20	*	78	29	29.8	12	144
21	13/16	78	29.8	29.8	12	144
22	7/8	78	31.8	30	9	108
23	29/32	78	33.8	30	9	108
24	15/16	78	33.8	30	9	108
25	31/32	78	35.8	30	6	72
26	1"	78	35.8	30	5	60
27	1-1/16	78	37.8	30	5	60
28	1-1/8	78	39.8	30		
29	*	78	39.8	30		
30	1-3/16	78	42.8	30.5		
31	*	78	43.8	32.5		
32	1-1/4	78	43.8	32.5		
33	*	78	44.8	32.5		
34	1-5/16	78	46.8	35.8		
35	1-3/8	78	46.8	35.8		
36	1-7/16	78	49.8	36.8		

## 3/4"Dr. Deep Impact Socket

Size mm	L mm	D2 Max mm
17	90	44
18	90	44
19	90	44
21	90	44
22	90	44
23	90	44
24	90	44
27	90	44
28	90	44
30	90	44
32	90	44
33	90	44
34	90	44
36	90	44
38	90	44
41	90	44
46	95	44
48	95	44
50	95	54
55	100	54
60	100	54
65	100	54

## 1"Dr. Deep Impact Socket

Size mm	L mm	D2 Max mm
19	90	54
21	90	54
22	90	54
24	90	54
27	90	54
30	90	54
32	90	54
33	92	54
34	92	54
35	92	54
36	92	54
38	92	54
41	92	54
43	95	54
44	95	54
46	95	54
48	95	54
50	95	54
55	100	54
60	100	54
65	100	54
70	100	54



# IMPACT BIT SOCKET

# IMPACT EXTENSION BAR

CR  
MO





## 1/2"Dr. Impact Bit Socket

Size	L mm		
MP6	78	12	144
MP7	78	12	144
MP8	78	12	144
MP10	78	12	144
MP11	78	12	144
MP12	78	12	144
MP13	78	12	144
MP14	78	12	144





## 1/2"Dr. Impact Bit Socket

Size	L mm		
T30	78	12	144
T40	78	12	144
T45	78	12	144
T50	78	12	144
T55	78	12	144
T60	78	12	144
T70	78	12	144
T80	78	12	144





## 1/2"Dr. Impact Bit Socket

Size	L mm		
H6	78	12	144
H7	78	12	144
H8	78	12	144
H10	78	12	144
H12	78	12	144
H14	78	12	144
H17	78	12	144
H19	78	12	144



## 1/2"Dr. Impact Bit Socket

Size	L mm		
M5	78	12	144
M6	78	12	144
M8	78	12	144
M10	78	12	144
M12	78	12	144
M14	78	12	144
M16	78	12	144
M18	78	12	144



## 3/8"Dr. Impact Extension Bar

Size	L mm	
3"	75	
6"	150	
10"	250	



## 1/2"Dr. Impact Extension Bar

Size	L mm	
3"	75	
4"	100	
5"	125	
8"	200	
10"	250	



## 3/4"Dr. Impact Extension Bar

Size	L mm	
3"	75	
4"	100	
5"	125	
7"	175	
8"	200	
10"	250	
13"	325	
16"	400	

# IMPACT EXTENSION BAR

# IMPACT UNIVERSAL JOINT



## 1"Dr. Impact Extension Bar

Size	L mm
3"	75
5"	125
7"	175
8"	200
10"	250
13"	325
16"	400

CR  
MO



## 3/8"Dr. Impact Universal Joint

Size	L mm	D mm	
3/8	49	27	15



## 1/2"Dr. Impact Universal Joint

Size	L mm	D mm	
1/2	64	31	20



## 3/4"Dr. Impact Universal Joint

Size	L mm	D mm	
3/4	93	42	20



## 1"Dr. Impact Universal Joint

Size	L mm	D mm	
1"	124	60	20

# IMPACT ADAPTOR

# IMPACT SOCKET

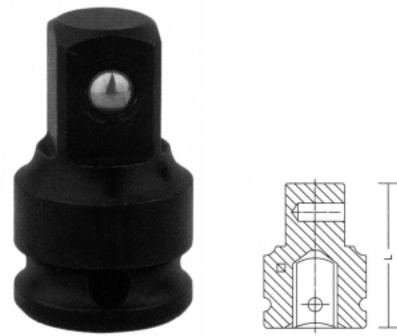

## 3/8"Dr. Impact Adaptor

Size	L mm	
3/8-1/2	36	15
3/8-1/4		



## 1/2"Dr. Impact Adaptor

Size	L mm	
1/2-3/8	48	20
1/2-3/4	38	20



## 3/4"Dr. Impact Adaptor

Size	L mm	
3/4-1/2	57	12
3/4-1"	63	12



## 1"Dr. Impact Adaptor

Size	L mm	
1"-3/4	70	20
1"-1/2	70	20



## Non-Marring Lug Nut Socket

Size mm	L mm	
17	80	12
19	80	12
21	80	12
22	80	12
23	80	12



## Flip Impact Socket

Size	L mm	
17/19mm	80	12
7/8(21mm)	80	12
3/4(13/16)	80	12



## Non-Marring Lug Nut Socket

Size mm	L mm	
17	80	12
19	80	12
21	80	12
22	80	12
23	80	12

## HD-P018

22 Pcs Socket Set 1/2"



- 18Pcs - 1/2"DR.Sockets(12PT):8,9,10,11,12,13,14,15,16,17,18,19,21,22,24,27,30,32mm
- 1Pc - 1/2"DR.Ratchet Handle with Quick Release 45 Teeth
- 2Pcs - 1/2"DR.Extension Bar 125mm &250mm
- 1Pc -1/2" Sliding T-Bar 250mm

## HD-P019

82pcs socket set(1/4"&1/2")



- 13pcs - 1/4"dr.sockets: 4,4.5,5,5.5,6,7,8,9,10,11,12,13,14mm
- 2pcs - 1/4"dr.extension bars: 2"& 4"
- 1pc - 1/4"dr.flexible extension:6"
- 1pc - 1/4"dr.universal joint
- 1pc - 1/4dr.spinner handle: 6"
- 1pc - 1/4"dr.sliding T bar
- 1pc - 1/4"dr.quick ratchet handle
- 12pcs - 1/2"dr.sockets:14,15,16,17,18,19,20,22,24,27,30,32mm
- 17pcs - 1/4"dr.bit sockets: SL4,5,5,7 Ph1,2 Pz1,2 Hex3,4,5,6 T8,10,15,20,25,30
- 2pcs - 1/2"dr.extension bars: 5"& 10"
- 2pcs - 1/2"dr.spark plug sockets: 16mm & 21mm
- 1pc - 3-way adaptor
- 1pc - 1/2"dr.universal joint
- 1pc - 1/2"dr.quick ratchet handle
- 1pc - 1/2"dr.bit holder
- 15pcs - Bits:SL8,10,12 Ph3,4 Pz3,4 Hex8,10,12,14 T40,45,50,55
- 9pcs - Spanner:8,10,11,12,13,14,17,19,22mm
- 1pc - Blow case

## HD-P020

94pcs socket set(1/4"&1/2")

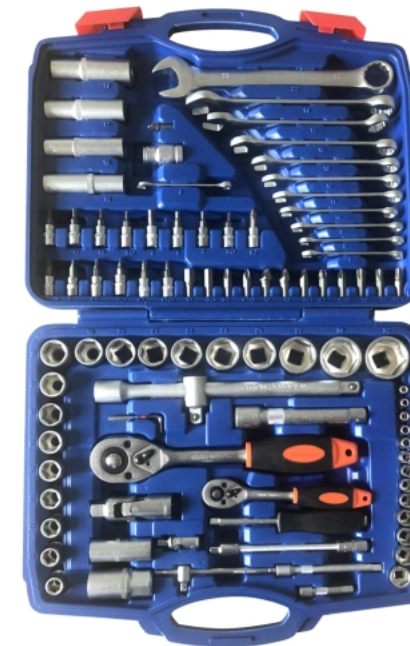

- 13pcs - 1/4"dr.socket: 4, 4.5,5 ,5.5,6,7,8,9,10,11,12,13,14 mm
- 2pcs - 1/4" dr extension bars: 2"& 4"
- 1pc - 1/4" dr.universal joint
- 1pc - 1/4" dr.quickratchet handle
- 1 pc 1/4" dr. spinner handle:6"
- 15pcs - 1/4"dr. bit socket:SL4,5,5,7 Ph1,2,Pz1,2, Hex 3,4,5,6,T8,10,15,20
- 1pc - 1/4" dr.flexible extension:6"
- 1pc - Dr.sliding T bar
- 1pc - 1/4" dr.bit adaptor
- 18pcs - 1/2" dr.sockets: 10,11,12,13,14,15,16,17,18,19,20,21,22,23,24,27,30,32mm
- 4pcs - 1/2" dr.deep sockets: 14,15,17,19 mm
- 2pcs - 1/2" dr.extension bars: 5 & 10"
- 2pcs - 1/2" dr.spark plug sockets: 16 mm & 21 mm
- 1pc - 1/2" dr. universal joint
- 1pc - 1/2" dr.quick ratchet handle
- 1pc - 1/2" dr.bit holder
- 1pc - 3-way adaptor
- 12pcs - Bits(30L):SL8,10,12,T40,45,50 Ph3,4 Pz 3,4 Hex 8,10
- 3pcs - Hex key wrenches: 1.5, 2, 2.5 mm
- 12pcs - Combination wrench: 6-7-8-9-10-11-12-13-15-17-19-22
- 1pc - Blow case

## HD-P021

110pcs socket set(1/4"&1/2")



- 17pcs - 1/2"dr.sockets: 10,11,12,13,14,15,16,17,18,19,20,21,22,24,27,30,32mm
- 5pcs - 1/2"dr.deep sockets: 14,15,17,19,22mm
- 2pcs - 1/2"dr.extension bars: 5"&10"
- 1pc - 1/2"dr.universal joint
- 8pcs - 1/2"dr.torx sockets: E10,E11,E12,E14,E16,E18,E20,E24
- 1pc - 1/2"dr.quick ratchet handle
- 2pcs - 1/2"dr.spark plug sockets: 16mm & 21mm
- 1pc - 3-way adaptor
- 13pcs - 1/4"dr.sockets:4,4.5,5,5.5,6,7,8,9,10,11,12,13,14mm
- 8pcs - 1/4"dr.deep sockets: 6,7,8,9,10,11,12,13mm
- 2pcs - 1/4"dr.extension bars: 2"&4"
- 1pc - 1/4"dr.universal joint
- 1pc - 1/4"dr.quick ratchet handle
- 5pcs - 1/4"dr.torx sockets: E4,E5,E6,E7,E8
- 1pc - 1/4"dr sliding T bar
- 4pcs - Hex key wrenches: 1.27,1.5,2,2.5mm
- 1pc - 1/4"dr.spinner handle 6"
- 1pc - 1/4"dr.bit adaptor
- 18pcs - 1/4"dr.bit sockets: SL4,5,5,7 Ph1,2 Pz1,2 Hex3,4,5,6 T8,10,15,20,25,27,30
- 17pcs - Bits:SL8,10,12 T40,45,50,55,60 Ph3,4 Pz3,4 Hex7,8,10,12,14
- 1pc - 1/2"dr.bit holder
- 1pc - Blow case



## HD-P016



32PCS Torx Bit Socket Set

10PCS 55mm:	10PCS 100mm:	6PCS 140mm:	6PCS 200mm:
T20	T20	T40	T40
T25	T25	T45	T45
T27	T27	T50	T50
T30	T30	T55	T55
T40	T40	T60	T60
T45	T45	T70	T70
T50	T50		
T55	T55		
T60	T60		
T70	T70		

30PCS HEX Bit Socket Set

9PCS 55mm:	8PCS 100mm:	7PCS 140mm:	6PCS 200mm:
H5	H5	H5	H5
H6	H6	H6	H6
H7	H7	H7	H7
H8	H8	H8	H8
H10	H10	H10	H10
H12	H11	H12	H12
H14	H12	H14	
H17	H13		
H19			



26PCS M Bit Socket Set

8PCS 55mm:	7PCS 100mm:	7PCS 140mm:	4PCS 200mm:
M5	M5	M5	M8
M6	M6	M6	M10
M8	M8	M8	M12
M9	M9	M9	M14
M10	M10	M10	
M12	M12	M12	
M14	M14	M14	
M16			

Material: Sockets 50BV30; Bits CRV or S2  
Three Blow cases packed in a box



## HD-P017

7-Drawer Roller Tool Cabinet with 196 PCS Hand Tools Assortment

1. Dimension:77.0x46x97cm(height include castors).
2. All steel construction (0.8mm construction &0.7mm drawer thickness)
3. All ball bearing drawers slides, 100% open.
4. Top work surface include plastic top tray with handles.
5. Aluminum drawer pulls with cardboard for easy access to the contains, self lockers for each drawer.
6. Side internal locking system with 2 keys.
7. Heavy-duty 5" x 1.5" castors, 2 fixed and 2 swiveled with brakes.



QTY	Name	Size
13PCS	1/4" Dr. Sockets	4,4.5,5.5,6,7,8,9,10,11,12,13,14MM
1PC	1/4" Sliding Bar	110MM
2PC	1/4" Dr. Extension Bar	2" & 4"
1PC	1/4" Universal Joint	
1PC	1/4" Dr. Ratchet Handle	72T
1PC	1/4" Spinner Handle	150MM
17PCS	1/2" Dr. Sockets	8,9,10,11,12,13,15,16,17,19,20,21,22,24,27,30,32MM
2PCS	1/2" Dr. Extension Bar	5" & 10"
1PC	1/2" Sliding Bar	250MM
1PC	1/2" Dr. Ratchet Handle	72T
1PC	1/2" Universal Joint	
17PCS	3/8" Dr. Socket	6,7,8,9,10,11,12,13,14,15,16,17,18,19,20,21,22MM
7PCS	3/8" Dr. Socket	E10, E11, E12, E14, E16, E18, E20
1PCS	3/8" Dr. Ratchet Handle	72T
1PC	3/8" Sliding Bar	162mm
2PCS	3/8" Dr. Extension Bar	3" & 6"
1PC	3/8" Universal Joint	
2PCS	3/8" Spark Plug Socket	16mm & 21mm
9PCS	Hex Key	1.5, 2, 2.5, 3, 4, 5, 6, 8, 10
9PCS	1/4" Dr. Deep Sockets	5, 6, 7, 8, 9, 10, 11, 12, 13MM
23PCS	1/4" Bits Sockcets	PH1,2,3 T8,10,15,20,25,27,30,40 PZ1,2,3 SL4,5,5.7 H3,4,5,6,7,8
17PCS	72T, Ratchet Wrench	6-7-8-9-10-11-12-13-14-15-16-17-18-19-20-21-22

QTY	Name	Size
8PCS	Double Open End Wrench	6x7, 8x9, 10x11, 12x13,14x15,16x17,18x19,20x22
27PCS	Screwdriver	SL:3X75,SL4X100,SL5.5X125,SL6.5X150; PH1X100;PH2X100;SL1.8X40,SL2.0X40,SL2.5X40,SL3.0X40;PH000X40;PH00X40;PH0X40;PH0X75;PH1X100;PH2X38;PH2X100;PH2X125;PH3X150;PH4X200;SL3X75;SL3.5X75;SL4X100;SL5.5X150;SL6X38;SL6.5X150;SL8X175
8PCS	9" Folding Hex Key	T9,T10,T15,T20,T25,T27,T30,T40
1PC	Angle Ruler	
1PC	Spirit Level	9"
1PC	Hack Saw	150MM
1PC	Fold Ruler	1.0M
1PC	Tape Measure	16FT/5M
5PCS	File Set	8"file Half round, 8"round file, 8"flat file, 8" triangle file, 8"square file
3PCS	Plier Set	8" Long Nose Plier, 8" Combination Plier, 7.5" Diagonal Cutting Plier
1PC	10" Locking Plier	10"
1PC	10" Water Pump Plier	10"
1PC	500G Chipping Hammer	500g
1PC	Mallet Hammer	300g
6PCS	Hex Key with Crutch Handle	6.0x150mm;5.0x150mm;4.0x150mm;3.0x100mm;2.5x100mm;2.0x100mm

## HD-P012

186pcs tool set in aluminium case



- 6pcs-precision s/d carbon steel,heated
- 9pcs-hex key
- 24pcs-bits
- 1pc-bit handle carbon steel,heated
- 1pc-bit holder
- 14pcs-screwdriver
- 1pc-7.5"daigonal plier
- 1pc-8"adjustable wrench
- 1pc-9"pump plier
- 1pc-elec.tester 100-250v
- 1pc-8"longnose plier
- 1pc-6"combination plier
- 10pcs-combination wrench 6-8-10-11-12-13-14-15-17-19
- 12pcs-1/4dr\*4-4.5-5-5.5-6-7-8-9-10-11-12-13
- 17pcs-1/2dr\*10-11-12-13-14-15-16-17-18-19-20-21-22-23-24-27-30
- 2pcs-1/2dr\*16&21mm plug sockets
- 1pc-1/2universal joint
- 1pc-Y bits Cr-v,heated
- 1pc-1/2 sliding T bar
- 1pc-1/4 universal joint
- 1pc-1/4\*2" extension bar
- 1pc-1/4 sliding T bar

- 1pc-1/4\*4" extension bar
- 1pc-1/2dr\*5" extension bar
- 1pc-1/4 ratchet handle
- 1pc-1/2 ratchet handle
- 1pc-flexible extension 6"
- 1pc-spinner handle
- 2pcs-nylon clamp3.5"
- 60pcs-fastener
- 1pc-12OZ claw hammer
- 1pc-7"lock plier
- 1pc-8"crimping plier
- 1pc-measuring tape 5m
- 1pc-blue gun
- 2pc glue sticks
- 1pc 10"level
- 1pc elec.tape 10Y
- 1pc utility knife
- 1set/aluminum box+color label+shrink

1SETS/CTN  
CTN SIZE: 38.5X24X51CM  
N.W/G.W:14KGS/15KGS

## HD-P013

86PCS Tool Set with Metal Case



- | Quantity | Contents:            |
|----------|----------------------|
| 18pcs    | 1/2dr socket         |
| 1pcs     | 1/2dr ratchet handle |
| 1pcs     | 6" longnose plier    |
| 1pcs     | 6" combination plier |
| 1pcs     | utility knife        |
| 5pcs     | utility knife blades |
| 1pcs     | 5m tape measure      |
| 1pcs     | ratchet screwdriver  |
| 1pcs     | 1/4dr ratchet handle |
| 1pcs     | 1/4' extension bar   |
| 12pcs    | screwdriver bits     |
| 12pcs    | 1/4dr sockets        |
| 1pcs     | universal joint      |
| 1pcs     | 1/2dr extension bar  |
| 1pcs     | sliding bar          |
| 5pcs     | screwdriver          |
| 1pcs     | 10" water pump plier |
| 1pcs     | 7" locking plier     |
| 9pcs     | hex key              |
| 11pcs    | combination spanner  |
| 1pcs     | metal tool case      |

1SET/CTN  
CTN SIZE:54.5X22.5X25CM  
N.W/G.W:7.5KGS/8.5KGS

## HD-P014

108 PCS CHROME VANIDIUM STEELL SOCKET SET



- 1/2" DR..
- >1pc Coupler
- >5pcs Deep socket:14 15 17 19 22mm
- >17pcs Socket:10 11 12 13 14 15 16 17 18 19 20 21 22 24 27 30 32
- >8pcs Socket:E10 E11 E12 E14 E16 E18 E22 E24
- >2pcs Sparx plug socket:16 21mm
- >2pcs Extension bar:5" & 10"(125mm&250mm)
- >1pc Ratchet handle
- >1pc Universal joint
- 1/4"DR..
- >18pcs Bits socket(-):4 5.5 7 (+):#1 #2 (\*):#1 #2 (PH):#3 #4 #5 #6 (TX):T8 10 15 20 25 27 30
- >1pc Flexible bar
- >1pc Universal joint
- >1pc TM bar
- >2pcs Extension bar:2" & 4"(50mm&100mm)
- >1pc Ratchet handle
- >13pcs Sockets:4 4.5 5.5 6 7 8 9 10 11 12 13 14mm
- >4pcs Sockets:E4 E5 E6 E7 E8
- >8pcs 1/4"DR Deep sockets:6 7 8 9 10 11 12 13mm
- >1pc bits AD
- >17pcs Bits:(TX):T40 45 50 55 60 (\*):#3 #4 (-):8 10 12 (PH):#8 #10 #12 #14 (+):#3 #4,AD
- >3pcs Hex key:1.5 2 2.5mm
- IN BMC (BLOW MOLD CASE)

Packing:3SETS/CTN  
N.W/G.W:19.5KGS/20.5KGS  
MERSURMENT:39.5X28.5X24.5CM

## HD-P015

94 PCS CHROME VANIDIUM STEELL SOCKET SET



- 1/2" DR..
- >1pc Coupler
- >4pcs Deep socket:14 15 17 19mm
- >18pcs Socket:10 11 12 13 14 15 16 17 18 19 20 21 22 23 24 27 30 32
- >2pcs Sparx plug socket:16 21mm
- >2pcs Extension bar:5" & 10"(125mm&250mm)
- >1pc Ratchet handle
- >1pc Universal joint
- 1/4"DR..
- >17pcs Bits socket(-):4 5.5 7 (+):#1 #2 (\*):#1 #2 (PH):#3 #4 #5 #6 (TX):T8 10 15 20 25 30
- >1pc Doble-end spinner handle
- >1pc Flexible bar
- >1pc Universal joint
- >1pc T bar
- >2pcs Extension bar:2" & 4"(50mm&100mm)
- >1pc Ratchet handle
- >13pcs Sockets:4 4.5 5.5 6 7 8 9 10 11 12 13 14mm
- >8pcs 1/4"DR Deep sockets:6 7 8 9 10 11 12 13mm
- >1pc bits AD
- >16pcs Bits:(TX):T40 45 50 55 (\*):#3 #4 (-):8 10 12 (PH):#8 #10 #12 #14 (+):#3 #4,AD
- >3pcs Hex key:1.5 2 2.5mm
- IN BMC (BLOW MOLD CASE)

Packing:3SETS/CTN  
N.W/G.W:17.5KGS/18.5KGS  
MERSURMENT:39.5X29X24.5CM

## HD-P008

111pcs 1/4" 3/8" 1/2" DR. Socket set



- 1/2" :14,15,17,19,20,21,22,23,24mm(L=38mm); 27,30,32mm(L=42mm)
- 3/8" :9,10,11,12,13,14,15,16mm(L=28mm); 17,18,19mm(L=30mm);
- 1/4" :3.5,4,4.5,5,5.5,6,7,8,9,10,11,12,13, mm (L=0.8,152.4mm); CrV 50BV30;
- 1/2" (127,254mm); 3/8" (76,152.4mm); 1/4" (50.8,152.4mm);CrV 50BV30;
- 1/2" :3/8" ,1/4" ,CrV 50BV30;
- 1/2" :3/8" ,1/4" ,CrV 50BV30;
- 1/2" :16,21mm;3/8" ,16,21mmCrV 50BV30;
- 1/2" ,3/8" ,1/4" ,T72,CrV 6140;
- 1/4" (150mm); CrV 50BV30;
- 3/8" x5/16, 1/2" x5/16; CrV;
- 5/16" T27,T30,T35,T40,T45(L=30mm);AlSI S2;
- 5/16" PH2,PH3 (L=30mm);AlSI S2;
- 5/16" PZ2,PZ3 (L=30mm);AlSI S2;
- 5/16" 5.5,6,6.5mm (L=30mm);AlSI S2;
- 5/16" 6.6,5,8mm (L=30mm);AlSI S2;
- 1/4" T8,T10,T15,T20,T25; AlSI S2/ CrV 50BV30;
- 1/4" PH1,PH2;AlSI S2/ CrV 50BV30;
- 1/4" PZ1,PZ2;AlSI S2/ CrV 50BV30;
- 1/4" T10,T15,T20,T25,T40; AlSI S2/ CrV 50BV30;
- 1/4"H3,4,5,6mm;AlSI S2/ CrV50BV30
- 1/4"4,5,5.5,6.5mm;AlSI S2/ CrV50BV30
- 8,9,10,11,12,13,14,15,16,17,18,19 mm;CrV;
- 1.5,2,2.5mm;CrV6150

## HD-P009

120pcs 1/4" 3/8" 1/2" DR.Socket set



- 1/2" :20,21,22,24mm(L=38mm) 27,30,32mm(L=42mm)
- 3/8" :9,10,11,12,13,14,15,16mm (L=28mm);17,18,19mm(L=30mm);
- 1/4" :4,5,6,7,8,9,10,11,12,13mm(L=25mm); CrV 50BV30;
- 3/8" :13,14,15,17mm(L=63mm)
- 1/4" :8,9,10,12mm(L=50mm);CrV50BV30;
- 1/2" (127,254mm); 3/8" (76,152.4mm); 1/4" (50.8mm);CrV50BV30;
- 1/2" ,3/8" ,1/4" ,CrV 50BV30;
- 3/8" :16,21mm;CrV 50BV30
- 1/2" ,3/8" ,1/4" ,T72,CrV 6140;
- 1/4" (150mm);CrV 50BV30;
- 1/4" :T10,T15,T20,T25,T27,T30,T40(L=25mm);AlSI S2;
- 1/4" x1/4" ;CrV;
- 3/8" :T20,T30,T40,T45,T50,T55,T60;AlSI S2/ CrV 50BV30;
- 3/8" :PH1,PH2;AlSI S2/ CrV 50BV30;
- 3/8" :PZ1,PZ2;AlSI S2/ CrV50BC30;
- 3/8" :5.5,6.5mm;AlSI S2/ CrV50BC30;
- 3/8" :3,4,5,6mm;AlSI S2/ CrV 50BV30;
- 8,9,10,11,12,13,14,17,18,19mm;CrV;
- 1/4" x5/32" ,1/4" x3/16" ,1/4" x7/32" , 1/4" x1/4" ,1/4" x9/32" ,1/4" x5/16" , 1/4" x11/32" ,1/4" x3/8" ,1/4" x7/16" , 1/4" x1/2" ,3/8" x3/8" ,3/8" x7/16" , 3/8" x1/2" ,3/8" x9/16" ,3/8" x5/8" , 3/8" x11/16" ,3/8" x3/4" ,3/8" x7/8" , 1/2" x15/16" ,1/2" x1" ,1/2" x1-1/16" , 1/2" x1-1/4" ,CrV 50BV30;
- 1/2" :17,19,21,23mm, CrV 50BV30;
- 3/8" :E8,E10,E11,E12,E14,E16,E18,E20mm; CrV 50BV30;

## HD-P010

150pcs 1/4" 3/8" 1/2" DR. Socket set

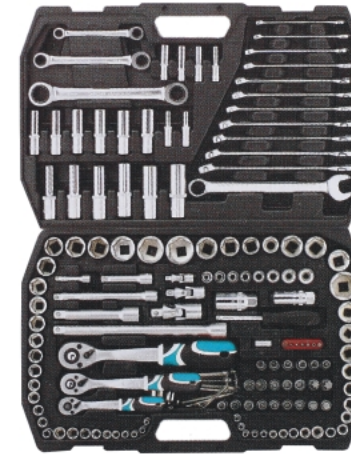

- 1/2" :20,21,22,24mm(L=38mm) 27,30,32mm(L=42mm)
- 3/8" :9,10,11,12,13,14,15,16mm (L=28mm);17,18,19mm(L=30mm);
- 1/4" :4,5,6,7,8,9,10,11,12,13mm(L=25mm); CrV 50BV30;
- 1/2" :10,12,13,14,17,19mm(L=76mm) 3/8" :10,11,12,13,14,15mm(L=63mm) 1/4" :4,5,6,7,8,9mm(L=50mm);CrV 50BV30;
- 1/2" (127,254mm); 3/8" (76,152.4mm); 1/4" (50.8mm);CrV50BV30;
- 1/2" ,3/8" ,1/4" ,CrV 50BV30;
- 3/8" :16,21mm;CrV 50BV30
- 1/2" ,3/8" ,1/4" ,T72,CrV 6140;
- 1/4" (150mm);CrV 50BV30;
- 1/4" :T10,T15,T20,T25,T27,T30,T40(L=25mm);AlSI S2;
- 1/4" x1/4" ;CrV;
- 3/8" :4,5,5,6.5mm;AlSI S2/ CrV50BC30;
- 3/8" :PH1,PH2;AlSI S2/ CrV 50BV30;
- 3/8" :PZ1,PZ2;AlSI S2/ CrV50BC30;
- 3/8" :T20,T30,T40,T45,T50,T55,T60;AlSI S2/ CrV 50BV30;
- 3/8" :3,4,5,6,8,10mm;AlSI S2/ CrV 50BV30;
- 8,9,10,11,12,13,14,17,18,19mm;CrV;
- 1/4" x5/32" ,1/4" x3/16" ,1/4" x7/32" , 1/4" x1/4" ,1/4" x9/32" ,1/4" x5/16" , 1/4" x11/32" ,1/4" x3/8" ,1/4" x7/16" , 1/4" x1/2" ,3/8" x3/8" ,3/8" x7/16" , 3/8" x1/2" ,3/8" x9/16" ,3/8" x5/8" , 3/8" x11/16" ,3/8" x3/4" ,3/8" x7/8" , 1/2" x15/16" ,1/2" x1" ,1/2" x1-1/16" , 1/2" x1-1/4" ,CrV 50BV30;
- 1/2" :17,19,21,23mm, CrV 50BV30;
- 3/8" :E8,E10,E11,E12,E14,E16,E18,E20mm;CrV 50BV30;
- 8x10,12x13,17x19mm;
- 1.5,2,2.5,3,4,4.5,7,8,10mm;CrV 6150

## HD-P011

215pcs 1/4" 3/8" 1/2" DR. Socket set

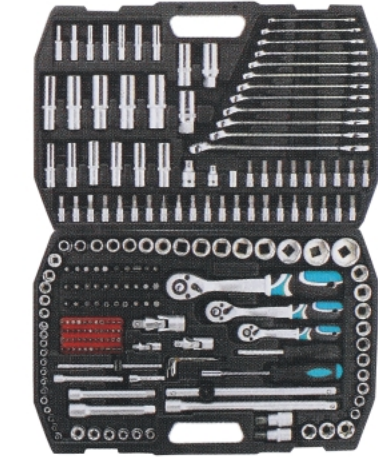

- 1/2" :20,21,22,24mm(L=38mm) 27,30,32mm(L=42mm)
- 3/8" :10,11,12,13,14,15,16mm (L=28mm);17,18,19mm(L=30mm);
- 1/4" :4,5,6,7,8,9,10,11,12,13mm(L=25mm); CrV 50BV30;
- 1/2" :16,17,18,19,22mm(L=76mm) 3/8" :10,11,12,13,14,15mm(L=63mm) 1/4" :4,5,6,7,8,9,10mm(L=50mm);CrV 50BV30;
- 1/2" (127,254mm);3/8" (125mm); 1/4" (50.8,101.6mm);CrV50BV30;
- 1/2" ,3/8" ,1/4" ,CrV 50BV30;
- 1/2" :16,21mm;3/8" :18mm;CrV 50BV30
- 1/2" (255mm);1/4" (152.4mm);CrV50BV30;
- 1/2" ,3/8" ,1/4" ,T72,CrV 6140;
- 1/4" (150mm);CrV50BV30;
- 1/4" (220mm);CrV6140;
- 1/4" x1/4" ,3/8" x5/16" ,1/2" x5/16" , 5/6" :5,5,6,6.5,7,8mm(L=30mm;AlSI S2) 1/4" :5,5,6,6.5,7,8mm(L=25mm;AlSI S2)
- 5/6" :5,6,8,10mm(L=30mm;AlSI S2) 1/4" :5,6,8mm(L=25mm;AlSI S2) 1/4" :5,6,8,10mm(L=25mm;AlSI S2)
- 5/6" :T25,T27,T30,T35,2xT40,T45,T50 (L=30mm);AlSI S2/ CrV 50BV30;
- 1/4" :T25,T27,T30,T35,2xT40,T45,T50 (L=25mm);AlSI S2/ CrV 50BV30;
- 5/6" :T27,T30,T35,T40,T45,T50 (L=30mm);AlSI S2/ CrV 50BV30;
- 1/4" :T27,T30,T35,T40,T45,T50 (L=25mm);AlSI S2/ CrV 50BV30;
- 5/6" :PH3,PH4(L=30mm);AlSI S2;
- 1/4" :PH3,PH4(L=25mm);AlSI S2;
- 5/6" :PZ3,PZ4(L=30mm);AlSI S2;
- 1/4" :PZ3,PZ4(L=25mm);AlSI S2;
- 5/6" :6,6,5,8mm(L=30mm);AlSI S2;
- 1/4" :6,6,5,8mm(L=25mm);AlSI S2;
- 1/4" :3,4,5,6mm(L=25mm);AlSI S2;
- 1/4" :S1,S2(L=25mm);AlSI S2;
- 1/4" :4,6,8mm(L=25mm);AlSI S2;
- 1/4" :6,8,10mm(L=25mm);AlSI S2;
- 1/4" :1,2,3mm(L=25mm);AlSI S2;
- 1/2" :T55,T60;AlSI S2/ CrV 50BV30;
- 1/4" :T25,T27,T30,T35,2xT40,T45,T50; AlSI S2/ CrV 50BV30;
- 1/4" :T27,T30,T35,T40,T45,T50; AlSI S2/ CrV 50BV30;
- 1/4" :5,5,6,6.5,7,8mmAlSI S2/ CrV 50BV30;
- 1/4" :PZ3,PZ4;AlSI S2/ CrV 50BV30;
- 1/4" :PZ3,PZ4;AlSI S2/ CrV 50BV30;
- 1/4" :6,6,5,8mmAlSI S2/ CrV 50BV30;
- 8,9,10,11,12,13,14,17,18,19,22mm;CrV;
- 1.27,1.5,2,2.5,3,4,4.5mm;CrV 6150
- 1/2" :E20,E22,E24;
- 3/8" :E10,E11,E12,E14,E16,E18;
- 1/4" :E4,E5,E6,E7,E8,CrV 6150

## HD-P003

77pcs 1/4" 1/2" DR.Socket set

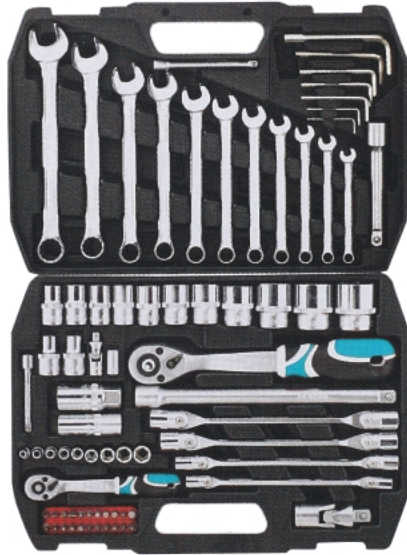

1/2" :10,11,12,13,14,15,17,19,22,24mm(L=38mm);27,30,32mm(L=42mm)  
1/4" :4,5,6,7,8,9,10,11,12mm(L=42mm);

1/2" :127,254mm);1/4" x76,101.6mm); CrV 50BV30;

1/2" :1/4" CrV 50BV30;

1/2" :16.21mm; CrV 50BV30;

1/4" :CrV 50BV30;

1/4" :T10, T15, T20, T25, T30 (L=25mm); AISI S2;

1/4" :PH0, PH1, PH2, PH3 (L=25mm); AISI S2;

1/4" :PZ1, PZ2, PZ3, (L=25mm); AISI S2;

1/4" :3,4,5,5,7mm (L=25mm); AISI S2;

1/4" :2,3,4,5,6mm (L=25mm); AISI S2;

1/4" x1/4" :CrV;

7,8,9,10,11,12,13,14,15,17,19mm;CrV;

14x15,12x13,10x11,8x9mm; CrV 6140;

1/2" ,1/4" ,2T;CrV 6140;

1.5,2,2.5,5,6,8,10mm;CrV 6150

## HD-P004

82pcs 1/2" DR.Socket set



1/2" :14,15,16,17,18,19,20,22,24mm(L=38mm);27,30,32mm(L=42mm);  
1/4" :4,4.5,5,5.5,6,7,8,9,10,11,12,13,14mm (L=25mm); CrV 50BV30;

1/2" :127,254mm);1/4" (50.8,101.6mm); CrV 50BV30;

3/8"(F)x1/2"(M);CrV 50BV30;

1/4" :150mm);CrV 6140;

1/2" ,1/4" :CrV 50BV30;

1/2" :16.21mm; CrV 50BV30;

1/4" :152mm); CrV 50BV30;

1/2" :1/4" :72T;CrV 6140;

1/4" :150mm);CrV 50BV30;

1/4"x1/4",1/2"x5/16", CrV50BV30

5/16" :PH3,PH4 (L=30mm);AISI S2;

5/16" :PZ3,PZ4 (L=30mm);AISI S2;

5/16" :8,10,12mm (L=30mm);AISI S2;

5/16" :8,10,12,14mm (L=30mm);AISI S2;

5/16" :T40,T45,T50,T55 (L=30mm);AISI S2;

1/4" :T8,T10,T15,T20,T25,T30;AISI S2/ CrV 50BV30;

1/4" :PH1,PH2;AISI S2/ CrV 50BV30;

1/4" :PZ1,PZ2;AISI S2/ CrV 50BV30;

1/4" :3,4,5,6mm;AISI S2/ CrV 50BV30;

1/4" :4,5,5,7mm;AISI S2/ CrV 50BV30;

8,10,11,12,13,14,17,19,22mm;CrV

## HD-P006

94pcs 1/4" & 1/2" DR.Socket set

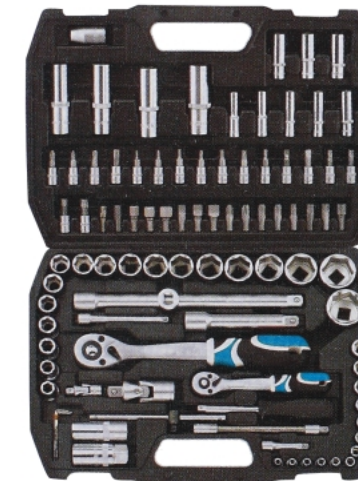

1/2" :10,11,12,13,14,15,17,19,20,21,22,23,24mm(L=38mm);27,30,32mm(L=42mm).  
1/4" :4,4.5,5,5.5,6,7,8,9,10,11,12,13,14mm(L=25mm); CrV 50BV30;

1/2" :14,15,17,19mm(L=76mm);  
1/4" :6,7,8,9,10,11,12,13mm(L=50mm);CrV 50BV30;

1/2" :127,254mm);1/4(50.8,101.6mm); CrV 50BV30;

3/8" :F)x1/2(M); CrV 50BV30;

1/4" :150mm);CrV;

1/2" :1/4; CrV 50BV30;

1/2" :6,21mm; CrV 50BV30;

1/4" :152mm); CrV 50BV30;

1/2" :1/4" 72T;CrV 6140;

1/4" :150mm); CrV 50BV30;

1/4"x1/4";CrV 50BV30;

5/16" :8,10,12,14mm (L=30mm);AISI S2;

5/16" :8,10,12mm (L=30mm);AISI S2;

5/16" :PH3,PH4 (L=30mm);AISI S2;

5/16" :PZ3,PZ4 (L=30mm);AISI S2;

5/16" :T40,T45,T50,T55 (L=30mm);AISI S2;

1/2" x5/16", CrV 50BV30; 1/4"x1/4; CrV 50BV30;

1/4" :T8,T10,T15,T20,T25,T30; AISI S2/ CrV 50BV30;

1/4" :3,4,5,6mm; AISI S2/ CrV 50BV30;

1/4" :PZ1,PZ2;AISI S2/ CrV 50BV30;

1/4" :PH1,PH2;AISI S2/ CrV 50BV30;

1/4" :4,5,5,7mm; AISI S2/ CrV 50BV30;

1.5,2,2.5mm;CrV6150

## HD-P007

108pcs 1/4" 1/2" DR. Socket set

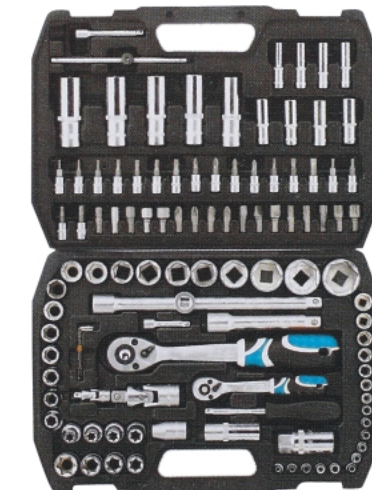

1/2" :10,11,12,13,14,15,17,19,20,21,22,23,24mm(L=38mm);27,30,32mm(L=42mm)  
1/4" :4,4.5,5,5.5,6,7,8,9,10,11,12,13,14mm(L=25mm); CrV 50BV30;

1/2" :14,15,17,19,22mm(L=76mm);  
1/4" :6,7,8,9,10,11,12,13mm(L=50mm);CrV 50BV30;

1/2" :127,254mm);1/4(50.8,101.6mm); CrV 50BV30;

1/2" :1/4;CrV 50BV30;

1/2" :16,21mm; CrV 50BV30;

1/4" :152,4mm);CrV;

1/2" :1/4" 72T; CrV6140

1/2" (F) x5/16"(F)

1/4" :150mm); CrV 50BV30;

1/4" :T8,T10,T15,T20,T25,T27,T30; AISI S2/ CrV 50BV30;

1/4" :PH1,PH2;AISI S2/ CrV 50BV30;

1/4" :PZ1,PZ2;AISI S2/ CrV 50BV30;

1/4" :4,5,5,6,5mm; AISI S2/ CrV 50BV30;

1/4" :3,4,5,6mm; AISI S2/ CrV 50BV30;

5/16" :PH3,PH4 (L=30mm);AISI S2;

5/16" :PZ3,PZ4 (L=30mm);AISI S2;

5/16" :T40,T45,T50,T55,T60; (L=30mm);AISI S2;

5/16" :8,10,12mm (L=30mm);AISI S2;

5/16" :7,8,10,12,14mm (L=30mm);AISI S2;













1/2" :E10,E11,E12,E14,E16,E18,E20,E24mm;

1/4" :E4,E5,E6,E7,E8mm;CrV 6150;

1.5,2,2.5mm;CrV6150



**HD-P001**  
58pcs 3/8" DR.Socket set

-  3/8" :6,7,8,9,10,11,12,13,14,15,16mm(L=28mm); 17,18,19,20,21,22,24mm(L=30mm);CrV50BV30;
-  3/8" :8,10,11,12,13,14,15,17,19mm (L=63mm);CrV 50BV30;
-  3/8" : (76,254mm);CrV 50BV30;
-  1/2" : (F) x 3/8" (M);CrV 50BV30;
-  3/8" : CrV 50BV30;
-  3/8" :16,21mm;CrV 50BV30;
-  3/8" :72T;CrV6140;
-  3/8" :T10,T15,T20,T25,T30,T40,T45,T50,T55; AISI S2/CrV 50BV30;
-  3/8" :PH1,PH2;PH3;AISI S2/CrV 50BV30;
-  3/8" :PZ1,PZ2; AISI S2/CrV 50BV30;
-  3/8" :5.5,6.5,8mm; AISI S2/CrV 50BV30;
-  3/8" :3,4,5,6,7,8,9,10mm; AISI S2/CrV 50BV30

**HD-S016**

M16pcs Conjoined Bit  
Length: 78mm  
1/2"=12.5mm CR-MO  
M4-M5-M6-M7-M8-M9-  
M10-M11-M12-M13-M14-  
M15-M16-M17-M18-M19











**HD-S017**

H16pcs Conjoined Bit  
Length: 78mm  
1/2"=12.5mm CR-MO  
H5-H6-H7-H8-H9-H10-  
H11-H12-H13-H14-H15-  
H17-H18-H19-H20-H21











**HD-P002**  
38pcs 1/2" DR.Socket set

-  1/2" :10,11,12,,13,14,15,16,17,18,19,20,21,22, 23,24mm(L=38mm);27,30,32,mm(L=42mm); CrV 50BV30;
-  1/2" :10,13,17,19mm(L=76mm);CrV 50BV30;
-  1/2" : (127,254mm);CrV 50BV30;
-  1/2" :CrV 50BV30;  1/2" :16,21mm; CrV 50BV30;
-  1/2" : (255mm);CrV 50BV30;
-  8,10,11,12,13,14,17,19,22mm;CrV;
-  1/2" :72T;CrV6140



**HD-P005**  
46pcs 1/2" DR.Socket set

-  1/2" :8,9,10,11,12,13,14,15,16,17,18, 19,20,21,22,23,24mm(L=38mm);27,30, 32mm(L=42mm); CrV 50BV30;
-  1/2" :10,12,13,14,15,17,19mm (L=76mm);CrV 50BV30;
-  1/2" : (127,254mm);CrV 50BV30;
-  3/8" :CrV 50BV30;
-  1/2" :CrV 50BV30;
-  1/2" :6.21mm;CrV 50BV30;
-  1/2" : (254mm);CrV 50BV30;
-  1/2" x 3.8", 1/2" x 7/16", 1/2" x 1/2", 1/2" x 9/16", 1/2" x 5/8", 1/2" x 11/16", 1/2" x 3/4", 1/2" x 13/16", 1/2" x 7/8", 1/2" x 15/16", 1/2" x 1", CrV 50BV30;
-  1/2" x 2T;CrV6140

**HD-S018**

T16pcs Conjoined Bit  
Length: 78mm  
1/2"=12.5mm CR-MO  
T20-T25-T27-T30-T35-  
T40-T45-T50-T52-T55-  
T60-T65-T70-T80-T90-T100



## HD-S019

T8pcs Conjoined Bit  
1/2"=12.7mm CR-MO  
T30-T40-T45-T50-T55-T60-T70-T80



## HD-S020

H8pcs Conjoined Bit  
1/2"=12.7mm CR-MO  
H5-H6-H8-H10-H12-H14-H17-H19



## HD-S021

M8pcs Conjoined Bit  
1/2"=12.7mm CR-MO  
M5-M6-M8-M10-M12-M14-M16-M18

## HD-S022

10 PCS 1/2" WHEELINTERVENTIONSOCKET SET  
17mm helical socket  
19mm helical Socket  
21mm helical Socket  
17mm sheated socket (Blue)  
19mm sheated socket (Gold)  
21mm sheated socket (Red)  
18.5 and 19.5mm reversible socket  
20.5 and 21mm reversible socket  
1/2" impact extension 75mm  
pin driver @8-12mm



## HD-S023

10 PCS 1/2" IMPACT SOCKET SET  
● 15, 17, 19, 21, 22, 23, 24mm  
● 7/8"  
● 17mm  
● 21mm

## HD-S024

21件油底壳放油螺丝工具  
四方批头: 5/16, 3/8 7, 8, 10, 11, 12, 13, 14mm  
批头: 十二角M16, 六角花型T45, 内三角10mm, 内四方10mm  
六角批头: H8, 9, 10, 12, 13, 14, 17 3/8滑杆(165mm)



## HD-S007

24件套12.5mm系列套筒组套(24pcs 1/2" DR.Socket set)



18pcs 1/2" :10,11,12,13,14,15,16,17,18,19,20,21,22,23,24,27,30,32mm  
 1pcs:release ratchet handle  
 2pcs:extension bars (125,250mm)  
 1pcs:arched tyep quick crank handle  
 1pcs:unirersal joint  
 1pcs:sliding "T"handle  
 Material:CR-V

18件12.5mm系列六角制套筒 ( 10,11,12,13,14,15,16,17,18,19,20,21,22,23,24,27,30,32mm )  
 1件专业快脱落棘轮扳手  
 2件转向接杆 ( 125mm,250mm )  
 1件弓型快速摇柄 ( 420mm )  
 1件万向接头  
 1件滑杆 ( 250mm )  
 材质: CR-V  
 表面处理: 镜面镀铬或亚光镀铬  
 包装方式: 彩盒 / 热收缩膜  
 外箱尺码: 4套 / 外箱, 45.5\*19.5\*22.5CM  
 净 / 毛重: 18 / 19KGS

## HD-S009

26件套12.5mm系列套筒组套(26pcs 1/2" DR.Socket set)



18pcs 1/2" :10,11,12,13,14,15,16,17,18,19,20,21,22,23,24,27,30,32mm  
 1pcs:release ratchet handle  
 2pcs:extension bars (125,250mm)  
 1pcs:star socket wrench(21mm)  
 1pcs:unirersal joint  
 1pcs:sliding "T"handle  
 Material:CR-V

18件12.5mm系列六角制套筒 ( 10,11,12,13,14,15,16,17,18,19,20,21,22,23,24,27,30,32mm )  
 1件专业快脱落棘轮扳手  
 2件转向接杆 ( 125mm,250mm )  
 1件火花塞套筒 ( 21mm )  
 1件万向接头  
 1件滑杆 ( 250mm )  
 材质: CR-V  
 表面处理: 镜面镀铬或亚光镀铬  
 包装方式: 彩盒 / 热收缩膜  
 外箱尺码: 4套 / 外箱, 45.5\*19.5\*22.5CM  
 净 / 毛重: 19 / 20KGS

## HD-S008

24件套12.5mm系列套筒组套(24pcs 1/2" DR.Socket set)



18pcs 1/2" :10,11,12,13,14,15,16,17,18,19,20,21,22,23,24,27,30,32mm  
 1pcs:release ratchet handle  
 2pcs:extension bars (125,250mm)  
 1pcs:flex handle  
 1pcs:unirersal joint  
 1pcs:sliding "T"handle  
 Material:CR-V

18件12.5mm系列六角制套筒 ( 10,11,12,13,14,15,16,17,18,19,20,21,22,23,24,27,30,32mm )  
 1件专业快脱落棘轮扳手  
 2件转向接杆 ( 125mm,250mm )  
 1件转向手柄 ( 380mm )  
 1件万向接头  
 1件滑杆 ( 250mm )  
 材质: CR-V  
 表面处理: 镜面镀铬或亚光镀铬  
 包装方式: 彩盒 / 热收缩膜  
 外箱尺码: 4套 / 外箱, 45.5\*19.5\*22.5CM  
 净 / 毛重: 18 / 19KGS

## HD-S010

18件套6.3x12.5mm系列花型旋具套筒  
 (18pcs 1/4" & 1/2" DR.TRX-Star Socket Bit set)



6pcs 1/4" DR.scorket bit set  
 (T10,T15,T20,T25,T30,T40)  
 6pcs 1/2" DR.scorket bit set  
 Length:55mm (T30,T40, T 45,T50,T55,T60)  
 6pcs 1/2" DR.scorket bit set  
 Length:100mm (T30,T40, T 45,T50,T55,T60)  
 Material:CR-V

6件6.3mm系列旋具套筒  
 花型 ( T10,T15,T20,T25,T30,T40 )  
 6件12.5mm系列55mm长旋具套筒  
 花型 ( T30,T40, T 45,T50,T55,T60 )  
 6件12.5mm系列100mm长旋具套筒  
 花型 ( T30,T40, T 45,T50,T55,T60 )  
 材质: CR-V  
 表面处理: 镜面镀铬或亚光镀铬  
 包装方式: 彩盒 / 热收缩膜  
 外箱尺码: 10套 / 外箱, 28.3x31.3x29.5CM  
 净 / 毛重: 17 / 18KGS

## HD-S003

19件套12.5mm系列套筒组套(19pcs 1/2" DR.Socket set)



14pcs 1/2" :10,11,12,13, 14,15,16,17,19,21,24,27,30,32mm  
 2pcs:extension bar (125mm,250mm)  
 1pcs:universal joint  
 1pcs:ratchet handle  
 1pcs:3way T-BAR adaptor  
 Material:CR-V

14件 12.5mm系列 六角公制套筒  
 10,11,12,13, 14,15,16,17,19,21,24,27,30,32mm  
 2件 转换接杆(125mm, 250mm)  
 1件 万向角接头  
 1件 棘轮扳手  
 1件 12.5mm系列 三用滑头  
 材质: CR-V  
 表面处理: 镜面镀铬或亚光镀铬  
 包装方式: 彩盒/热收缩膜  
 外箱尺寸: 4套/外箱 45.5\*19.5\*22.5CM  
 净/毛重: 16/17KGS

## HD-S005

24件套12.5mm系列套筒组套(24pcs 1/2" DR.Socket set)



18pcs 1/2" :10,11,12,13,14,15,16,17,18,19,20,21,22,23,24, 27,30,32mm  
 1pcs:125mm Extension Bar  
 1pcs:200mm Extension Bar  
 1pcs:Universal Joint  
 1pcs:300mm Sliding T Handle  
 1pcs:380mm Flex Handle  
 Reversible Ratchet  
 1pcs:21mm spark Plug Socket  
 Material:CR-V

18件 12.5mm系列 六角公制套筒  
 10,11,12,13,14,15,16,17,18,19,22,23,24,27,30,32mm  
 2件 转向接杆(250mm,125mm)  
 1件 万向接头  
 1件 滑杆  
 1件 380mm转向手柄  
 1件 棘轮扳手  
 材质: CR-V  
 表面处理: 镜面镀铬或亚光镀铬  
 包装方式: 彩盒/热收缩膜  
 外箱尺寸: 4套/外箱 45.5\*19.5\*22.5CM  
 净/毛重: 18/19KGS

## HD-S004

22件套9.5mm系列套筒组套(22pcs 3/8" DR.Socket set)



15pcs 3/8" :6,7,8,9,10,11,12,13,14,15,16,17,18,19,22mm  
 2pcs:extension bar (75mm,150mm)  
 2pcs:star socket wrench (16mm,21mm)  
 1pcs:sliding T bar  
 1pcs:ratchet handle  
 1pcs:universal joint  
 Material:CR-V

15件 9.5mm系列 六角公制套筒  
 6,7,8,9,10,11,12,13,14,15,16,17,18,19,22mm  
 2件 转换接杆(75mm,150mm)  
 2件9.5mm系列火花塞套筒 (16mm,21mm)  
 1件万向接头  
 1件滑杆  
 1件棘轮扳手  
 材质: CR-V  
 表面处理: 镜面镀铬或亚光镀铬  
 包装方式: 彩盒/热收缩膜  
 外箱尺寸: 4套/外箱 29\*28.5\*19.5CM  
 净/毛重: 18/19KGS

## HD-S006

24件套12.5mm系列套筒组套(24pcs 1/2" DR.Socket set)



18pcs 1/2" :10,11,12,13,14,15,16,17,18,19,20,21,22,23,24, 27,30,32mm  
 1pcs:release ratchet handle  
 2pcs:extension bars (125,250mm)  
 1pcs:star socket wrench(21mm)  
 1pcs:universal joint  
 1pcs:sliding "T"handle  
 Material:CR-V

18件12.5mm系列六角公制套筒 (10,11,12,13,14,15,16,17,18, 19,20,21,22,23,24,27,30,32mm)  
 1件专业快脱落棘轮扳手  
 2件转向接杆 (125mm,250mm)  
 1件火花塞套筒 (21mm)  
 1件万向接头  
 1件滑杆 (250mm)  
 材质: CR-V  
 表面处理: 镜面镀铬或亚光镀铬  
 包装方式: 彩盒 / 热收缩膜  
 外箱尺码: 4套 / 外箱, 45.5\*19.5\*22.5CM  
 净 / 毛重: 18 / 19KGS



## HD-S011

16件套12.5mm系列花型旋具套筒  
(16pcs 1/2" DR.TRX-Star Socket Bit set)

9pcs 1/2" DR.Star Socket ( E10,E11,E12,E14,E16,E18,E20,E22,E24 )  
7pcs 1/2" DR.scorket bit set  
(T30H,T40H, T 45H,T50H,T55H,T60H,T70H)  
Material:CR-V

9件套12.5mm系列花型套筒 ( E10,E11,E12,E14,E16,E18,E20,E22,E24 )  
7件12.5mm系列60mm长空旋具套筒  
中空花型 ( T30H,T40H, T 45H,T50H,T55H,T60H,T70H )  
材质: C R-V  
表面处理: 镜面镀铬或亚光镀铬  
包装方式: 彩盒 / 热收缩膜  
外箱尺码: 10套 / 外箱, 28.3x31.3x29.5CM  
净 / 毛重: 17 / 18KGS



## HD-S012

9件套12.5mm系列汽车维修专用旋具套筒  
( 9 pcs 1/2" DR.TRX-Star Socket Bit set)

Tyde: ( T20,T25,T30,T35,T40,T45,T50,T55,T60 )  
material:CR-V

花型 ( T20,T25,T30,T35,T40,T45,T50,T55,T60 )  
材质: C R-V  
表面处理: 镜面镀铬或亚光镀铬  
包装方式: 彩盒 / 热收缩膜  
外箱尺码: 10套 / 外箱, 19.8x22.5x28.5CM  
净 / 毛重: 9 / 10KGS



## HD-S013

22PCS Ratchet Screwdriver Bits & Socket Set

Quantity Contents:

8PCS 1/4"Dr.Socket:5-6-7-8-9-10-11-12MM  
11PCS 25MM x 1/4"BIT:SL4-SL5-PH0-PH1-PH2-PH3-T15-T20-H3-H4-H5  
1PC 1/4" x 25MM Bit Holder  
1PC 1/4" x 60MM Adaptor for sockets  
1PC Ratchet Screwdriver



## HD-S014

29PCS Screwdriver Socket Set

Quantity Contents:

9PCS 1/4"Dr.Socket:4-5-6-7-8-9-10-11-12MM  
16PCS 25MM x 1/4"BIT:SL4-SL5-SL6-PH0-PH1-PH2-PH3-  
PZ0-PZ1-PZ2-PZ3-T10-T15-T20-T25-T30  
1PC Magnetic Extender  
1PC 1/4" x 25MM adaptor  
1PC T-handle  
1PC Ratchet Screwdriver

## HD-S015

35 IN 1 Multi-Purpose Precision Screwdriver Set

Quantity Contents:

2PCS Extension Bar: 70MM、55MM  
1PC Connector:25MM  
2PC Multi-Purpose Precision Screwdriver set  
10PCS 1/4" Socket: M4-5-6-7-8-9-10-11-12-13  
20PCS Bits: T5-T6-T10-T15-T20-T25-T30-PH0-PH1-  
PH2-SL3-SL5-SL6-H4-H5-H6-Y2-Y3-PZ2-PZ4



## HD-S001

10件套12.5mm系列套筒组套(10pcs 1/2" DR.Socket set)



8pcs 1/2" : 8,10,12,14,17,19,21,24mm  
 1pcs:3 way T-BAR adaptor  
 1pcs:sliding "L" handles  
 Material:CR-V

8件 12.5mm系列 六角制套筒  
 8,10,12,14,17,19,21,24mm  
 1件 12.5mm系列 三用接头  
 1件 L型扳手  
 材质: CR-V  
 表面处理: 镜面镀铬或亚光镀铬  
 包装方式: 彩盒/热收缩膜  
 外箱尺寸: 10套/箱 29\*8.5\*25CM  
 净/毛重: 14/15KGS

## QUICK RELEASE RATCHET HANDLE 快速脱落棘轮扳手



Order No.	SIZE	Pooth	Length/mm	Weight/g
922601	1/4"	24	150	152.3
922602	3/8"	24	200	300.3
922603	1/2"	24	250	585.2
922604	1/4"	45	150	152.3
922605	3/8"	45	200	300.3
922606	1/2"	45	250	585.2
922607	1/4"	72	150	152.3
922608	3/8"	72	200	300.3
922608	1/2"	72	250	585.2

## HD-S002

16件套12.5mm系列套筒组套(16pcs 1/2" DR.Socket set)



13pcs 1/2" : 8,10,11,12,13,14,15,17,19,21,22,24,27mm  
 1pcs:ratchet handle  
 1pcs:flex handle  
 1pcs:extension bar (125mm)  
 Material:CR-V

13件 12.5mm系列 六角制套筒  
 8,10,11,12,13,14,15,17,19,21,22,24,27mm  
 1件 12.5mm系列 转换接口  
 1件 棘轮扳手  
 1件 380mm转向手柄  
 材质: CR-V  
 表面处理: 镜面镀铬或亚光镀铬  
 包装方式: 彩盒/热收缩膜  
 外箱尺寸: 4套/外箱 45.5\*12.5\*21.5CM  
 净/毛重: 13/14KGS

## HD- 12.5mm L型扳手 1/2" DR. L-Handle

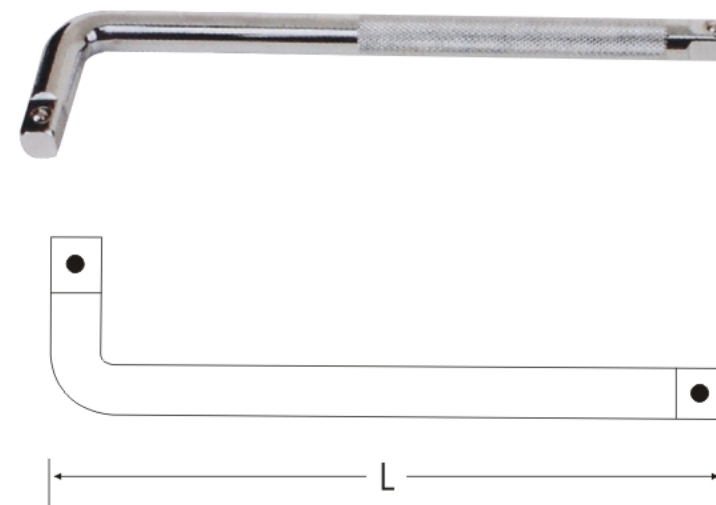

Order No.	SIZE	Lenght/mm	Weight/g
922001	1/2"	250	360
922002	1/2"	290	445
922003	1/2"	320	500

## 1/4" DR., SOCKETS REGULAR LENGTH, 6-POINT



Order No.	S/mm	Type	D2/mm	D1/mm	L/mm
HD1040	4	A	12	6.8	25
HD1045	4.5	A	12	7.1	25
HD1050	5	A	12	8	25
HD1055	5.5	A	12	8.3	25
HD1060	6	A	12	9.3	25
HD1070	7	A	12	10.5	25
HD1080	8	B	12	12	25
HD1090	9	B	13	13	25
HD1100	10	B	14	14	25
HD1110	11	B	16	16	25
HD1120	12	B	17	17	25
HD1130	13	B	18	18	25
HD1140	14	B	19.7	19.7	25



Order No.	S/inch	Type	D2/mm	D1/mm	L/mm
HD1005	5/32	A	12	6.8	25
HD1006	3/16	A	12	8	25
HD1007	7/32	A	12	8.3	25
HD1008	1/4	A	12	9.3	25
HD1009	9/32	A	12	10.5	25
HD1010	5/16	B	12	12	25
HD1011	11/32	B	13	13	25
HD1012	3/8	B	14	14	25
HD1014	7/16	B	16	16	25
HD1016	1/2	B	18	18	25
HD1018	9/16	B	19.7	19.7	25

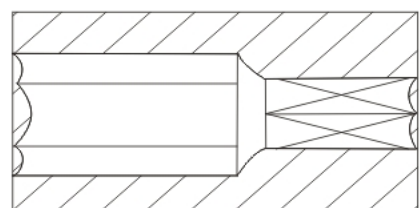

## 1/4" DR., SOCKETS DEEP LENGTH, 6-POINT



Order No.	S/mm	Type	D2/mm	D1/mm	L/mm
DEEP1040	4	A	12	6.8	50
DEEP1045	4.5	A	12	7.1	50
DEEP1050	5	A	12	8	50
DEEP1055	5.5	A	12	8.3	50
DEEP1060	6	A	12	9.3	50
DEEP070	7	A	12	10.5	50
DEEP1080	8	B	12	12	50
DEEP1090	9	B	13.2	13.2	50
DEEP1100	10	B	14.7	14.7	50
DEEP1110	11	B	16	16	50
DEEP1120	12	B	17	17	50
DEEP1130	13	B	18	18	50
DEEP1140	14	B	19.7	19.7	50



Order No.	S/inch	Type	D2/mm	D1/mm	L/mm
DEEP1005	5/32	A	12	6.8	50
DEEP1006	3/16	A	12	8	50
DEEP1007	7/32	A	12	8.3	50
DEEP1008	1/4	A	12	9.3	50
DEEP1009	9/32	A	12	10.5	50
DEEP1010	5/16	B	12	12	50
DEEP1011	11/32	B	13.2	13.2	50
DEEP1012	3/8	B	14.7	14.7	50
DEEP1014	7/16	B	16	16	50
DEEP1016	1/2	B	18	18	50
DEEP1018	9/16	B	19.7	19.7	50

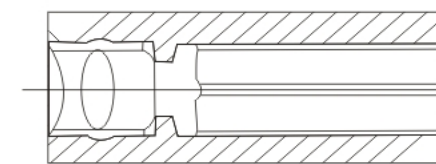

## 3/8" DR., SOCKETS REGULAR LENGTH, 6-POINT



Order No.	S/mm	Type	D2/mm	D1/mm	L/mm
HD2006	6	A	17	9.9	28
HD2007	7	A	17	10.6	28
HD2008	8	A	17	11.8	28
HD2009	9	A	17	13.2	28
HD2010	10	A	17	14.5	28
HD2011	11	A	17	15.7	28
HD2012	12	B	16	17	28
HD2013	13	B	16.5	18	28
HD2014	14	B	17	19.7	28
HD2015	15	B	18	20	28
HD2016	16	B	19	21	30
HD2017	17	B	20	23.5	30
HD2018	18	B	21	24.7	30
HD2019	19	B	23	26	30
HD2020	20	B	24	27.2	32
HD2021	21	B	25	28	32
HD2022	22	B	26	29.6	32
HD2023	23	B	27	31.6	32
HD2024	24	B	28	32	32

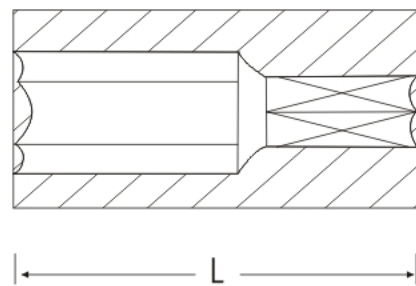
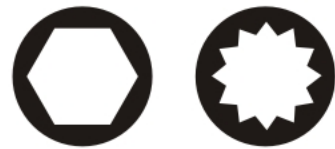

Order No.	S/inch	Type	D2/mm	D1/mm	L/mm
HD2008	1/4	A	17	9.9	28
HD2010	5/6	A	17	11.8	28
HD2011	11/32	A	17	13.2	28
HD2012	3/8	A	17	14.5	28
HD2013	13/32	A	17	14.5	28
HD2014	7/16	A	17	15.7	28
HD2016	1/2	B	16.5	18	28
HD2018	9/16	B	17	19.7	28
HD2019	19/32	B	18	21	28
HD2020	5/8	B	19	22	30
HD2022	11/16	B	20	23.5	30
HD2024	3/4	B	23	26	30
HD2025	25/32	B	24	27.2	32
HD2026	13/16	B	25	28	32
HD2028	7/8	B	26	29.6	32
HD2030	15/16	B	28	32	32

## 3/8" DR., SOCKETS DEEP LENGTH, 12-POINT



Order No.	S/mm	Type	D2/mm	D1/mm	L/mm
DEEP2006	6	A	17	9.9	63
DEEP2007	7	A	17	10.6	63
DEEP2008	8	A	17	11.8	63
DEEP2009	9	A	17	13.2	63
DEEP2010	10	A	17	14.5	63
DEEP2011	11	A	17	15.7	63
DEEP2012	12	B	16	17	63
DEEP2013	13	B	16.5	18	63
DEEP2014	14	B	17	19.7	63
DEEP2015	15	B	18	20	63
DEEP2016	16	B	19	21	63
DEEP2017	17	B	20	23.5	63
DEEP2018	18	B	21	24.7	63
DEEP2019	19	B	23	26	63
DEEP2020	20	B	24	27.2	63
DEEP2021	21	B	25	28	63
DEEP2022	22	B	26	29.6	63
DEEP2023	23	B	27	31.6	63
DEEP2024	24	B	28	32	63

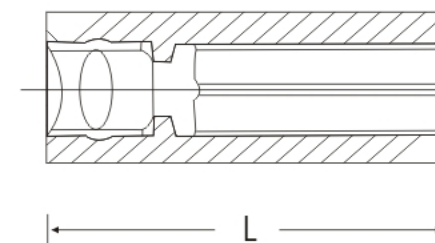

Order No.	S/inch	Type	D2/mm	D1/mm	L/mm
DEEP2008	1/4	A	17	9.9	63
DEEP2010	5/6	A	17	11.8	63
DEEP2011	11/32	A	17	13.2	63
DEEP2012	3/8	A	17	14.5	63
DEEP2013	13/32	A	17	14.5	63
DEEP2014	7/16	A	17	15.7	63
DEEP2016	1/2	B	16.5	18	63
DEEP2018	9/16	B	17	19.7	63
DEEP2019	19/32	B	18	21	63
DEEP2020	5/8	B	19	22	63
DEEP2022	11/16	B	20	23.5	63
DEEP2024	3/4	B	23	26	63
DEEP2025	25/32	B	24	27.2	63
DEEP2026	13/16	B	25	28	63
DEEP2028	7/8	B	26	29.6	63
DEEP2030	15/16	B	28	32	63

## 1/2" DR., SOCKETS REGULAR LENGTH, 6-POINT

## 1/2" DR., SOCKETS REGULAR LENGTH, 12-POINT



Order No.	S/mm	Type	D2/mm	D1/mm	L/mm
HD3008	8	A	22	13.2	38
HD3009	9	A	22	13.9	38
HD3010	10	A	22	15	38
HD3011	11	A	22	16.3	38
HD3012	12	A	22	17.6	38
HD3013	13	A	22	18.8	38
HD3014	14	A	22	20.4	38
HD3015	15	B	20.7	21.7	38
HD3016	16	B	21.5	23	38
HD3017	17	B	22	24	38
HD3018	18	B	22.3	25.5	38
HD3019	19	B	24	26	38
HD3020	20	B	25	28	38
HD3021	21	B	26	28	38
HD3022	22	B	27	30	40
HD3023	23	B	28	31.6	40
HD3024	24	B	30	32	42
HD3025	25	B	30	34	42
HD3026	26	B	30	35.5	42
HD3027	27	B	30	36	43
HD3028	28	B	32	38	43
HD3029	29	B	32	38	43
HD3030	30	B	34	40	46
HD3032	32	B	36	42	46

Order No.	S/mm	Type	D2/mm	D1/mm	L/mm
ST3008	8	A	22	13.2	38
ST3009	9	A	22	13.9	38
ST3010	10	A	22	15	38
ST3011	11	A	22	16.3	38
ST3012	12	A	22	17.6	38
ST3013	13	A	22	18.8	38
ST3014	14	A	22	20.4	38
ST3015	15	B	20.7	21.7	38
ST3016	16	B	21.5	23	38
ST3017	17	B	22	24	38
ST3018	18	B	22.3	25.5	38
ST3019	19	B	24	26	38
ST3020	20	B	25	28	38
ST3021	21	B	26	28	38
ST3022	22	B	27	30	40
ST3023	23	B	28	31.6	40
ST3024	24	B	30	32	42
ST3025	25	B	30	34	42
ST3026	26	B	30	35.5	42
ST3027	27	B	30	36	43
ST3028	28	B	32	38	43
ST3029	29	B	32	38	43
ST3030	30	B	34	40	46
ST3032	32	B	36	42	46

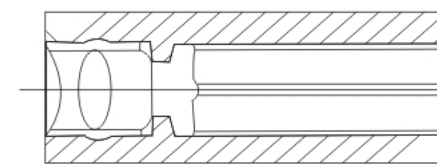
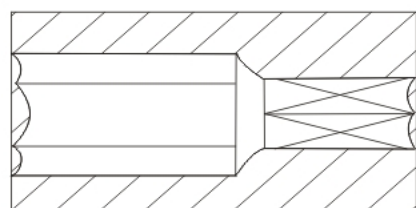
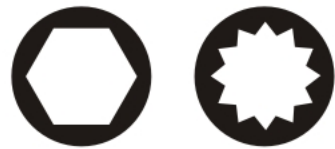

Order No.	S/inch	Type	D2/mm	D1/mm	L/mm
HD3010	5/6	A	22	13.2	38
HD3012	3/8	A	22	15	38
HD3014	7/16	A	22	16.3	38
HD3016	1/2	A	22	18.8	38
HD3018	9/16	A	22	20.4	38
HD3019	19/32	B	20.7	21.7	38
HD3020	5/8	B	21.5	23	38
HD3022	11/16	B	22	24	38
HD3024	3/4	B	23	26	38
HD3025	25/32	B	24	28	38
HD3026	13/16	B	25	28	38
HD3028	7/8	B	26	30	40
HD3030	15/16	B	28	32	42
HD3100	1	B	30	35.5	42
HD3102	1-1/16	B	30	36	43
HD3104	1-1/8	B	32	38	43
HD3106	1-3/16	B	34	40	46
HD3108	1-1/4	B	36	42	46

Order No.	S/inch	Type	D2/mm	D1/mm	L/mm
713010	5/6	A	22	13.2	38
713012	3/8	A	22	15	38
713014	7/16	A	22	16.3	38
713016	1/2	A	22	18.8	38
713018	9/16	A	22	20.4	38
713019	19/32	B	20.7	21.7	38
713020	5/8	B	21.5	23	38
713022	11/16	B	22	24	38
713024	3/4	B	23	26	38
713025	25/32	B	24	28	38
713026	13/16	B	25	28	38
713028	7/8	B	26	30	40
713030	15/16	B	28	32	42
713100	1	B	30	35.5	42
713102	1-1/16	B	30	36	43
713104	1-1/8	B	32	38	43
713106	1-3/16	B	34	40	46
713108	1-1/4	B	36	42	46

# 1/2" DR. SOCKETS

## 1/2" DR., SOCKETS DEEP LENGTH, 6-POINT

## 1/2" DR., SOCKETS DEEP LENGTH, 12-POINT

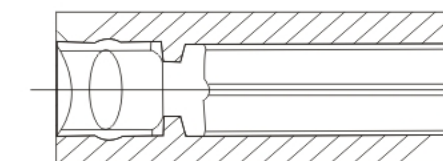
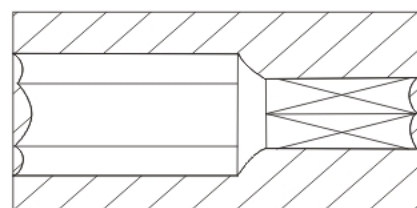

Order No .	S/mm	Type	D2/mm	D1/mm	L/mm
723008	8	A	22	13.2	77
723009	9	A	22	13.9	77
723010	10	A	22	15	77
723011	11	A	22	16.3	77
723012	12	A	22	17.6	77
723013	13	A	22	18.8	77
723014	14	A	22	20.4	77
723015	15	B	20.7	21.7	77
723016	16	B	21.5	23	77
723017	17	B	22	24	77
723018	18	B	22.3	25.5	77
723019	19	B	24	26	77
723020	20	B	25	28	77
723021	21	B	26	28	77
723022	22	B	27	30	77
723023	23	B	28	31.6	77
723024	24	B	30	32	77
723025	25	B	30	34	77
723026	26	B	30	35.5	77
723027	27	B	30	36	77
723028	28	B	32	38	77
723029	29	B	32	38	77
723030	30	B	34	40	77
723032	32	B	36	42	77

Order No .	S/inch	Type	D2/mm	D1/mm	L/mm
743010	5/6	A	22	13.2	77
743012	3/8	A	22	15	77
743014	7/16	A	22	16.3	77
743016	1/2	A	22	18.8	77
743018	9/16	A	22	20.4	77
743019	19/32	B	20.7	21.7	77
743020	5/8	B	21.5	23	77
743022	11/16	B	22	24	77
743024	3/4	B	23	26	77
743025	25/32	B	24	28	77
743026	13/16	B	25	28	77
743028	7/8	B	26	30	77
743030	15/16	B	28	32	77
743100	1	B	30	35.5	77
743102	1-1/16	B	30	36	77
743104	1-1/8	B	32	38	77
743106	1-3/16	B	34	40	77
743108	1-1/4	B	36	42	77

Order No .	S/mm	Type	D2/mm	D1/mm	L/mm
733008	8	A	22	13.2	77
733009	9	A	22	13.9	77
733010	10	A	22	15	77
733011	11	A	22	16.3	77
733012	12	A	22	17.6	77
733013	13	A	22	18.8	77
733014	14	A	22	20.4	77
733015	15	B	20.7	21.7	77
723016	16	B	21.5	23	77
723017	17	B	22	24	77
723018	18	B	22.3	25.5	77
723019	19	B	24	26	77
723020	20	B	25	28	77
723021	21	B	26	28	77
723022	22	B	27	30	77
723023	23	B	28	31.6	77
723024	24	B	30	32	77
723025	25	B	30	34	77
723026	26	B	30	35.5	77
723027	27	B	30	36	77
723028	28	B	32	38	77
723029	29	B	32	38	77
723030	30	B	34	40	77
723032	32	B	36	42	77

Order No .	S/inch	Type	D2/mm	D1/mm	L/mm
753010	5/16	A	22	13.2	77
753012	3/8	A	22	15	77
753014	7/16	A	22	16.3	77
753016	1/2	A	22	18.8	77
753018	9/16	A	22	20.4	77
753019	19/32	B	20.7	21.7	77
753020	5/8	B	21.5	23	77
753022	11/16	B	22	24	77
753024	3/4	B	23	26	77
753025	25/32	B	24	28	77
753026	13/16	B	25	28	77
753028	7/8	B	26	30	77
753030	15/16	B	28	32	77
753100	1	B	30	35.5	77
753102	1-1/16	B	30	36	77
753104	1-1/8	B	32	38	77
753106	1-3/16	B	34	40	77
753108	1-1/4	B	36	42	77



磁性强力套筒 MAGNETIC NUT SOCKET

Order No.	A/mm	A/mm	Length/mm	Weight/g
910301	6	1/4	42	17.5
910302	7		42	18.2
910303	8	5/16	42	20.8
910304	9		42	21.5
910305	10	3/8	42	24.2
910306	11	7/16	42	26.1
910307	12		42	29.5
910308	13	1/2	42	32
910309	6	1/4	45	18.3
910310	7		45	18.5
910311	8	5/16	45	21.1
910312	9		45	23
910313	10	3/8	45	26.1
910314	11	7/16	45	28.5
910315	12		45	30.8
910316	13	1/2	45	33
910317	6	1/4	48	19.8
910318	7	9/32	48	22
910319	8	5/16	48	22.1
910320	9	11/32	48	21.8
910321	10	3/8	48	26.6
910322	11	7/16	48	28.5
910323	12		48	35.4
910324	13	1/2	48	33.9
910325	6	1/4	65	26.7
910326	7		65	33
910327	8	5/16	65	31
910328	9		65	37.6
910329	10	3/8	65	35.5
910330	11	7/16	65	43.3
910331	12		65	52.9
910332	13	1/2	65	51.2

## 1/2 系列旋具套筒 1/2" Bit socket series

### 花形 TORX BIT SOCKETS

Order No.	SIZE	55	100	10	Order No.	SIZE	55	100	10	Order No.	SIZE	100	10
41020	T-20	55	100	10	41055	T-55	55	100	10	41450	T-45	100	10
41025	T-25	55	100	10	41060	T-60	55	100	10	41500	T-50	100	10
41027	T-27	55	100	10	41200	T-20	100	100	10	41520	T-52	100	10
41030	T-30	55	100	10	41250	T-25	100	100	10	41550	T-55	100	10
41040	T-40	55	100	10	41270	T-27	100	100	10	41600	T-60	100	10
41045	T-45	55	100	10	41300	T-30	100	100	10				
41050	T-50	55	100	10	41400	T-40	100	100	10				

### 中孔花形 TAMPER PROOF TORX BIT SOCKETS

Order No.	SIZE	100	10	Order No.	SIZE	100	10
43200	T-20	100	10	43450	T-45	100	10
43250	T-25	100	10	43500	T-50	100	10
43270	T-27	100	10	43550	T-55	100	10
43300	T-30	100	10	43600	T-60	100	10
43400	T-40	100	10				

### 12角 SPLINE BIT SOCKETS

Order No.	SIZE	55	100	10	Order No.	SIZE	55	100	10	Order No.	SIZE	100	10
42005	5mm	55	100	10	42014	14mm	55	100	10	42100	10mm	100	10
42006	6mm	55	100	10	42050	5mm	100	100	10	42120	12mm	100	10
42008	8mm	55	100	10	42060	6mm	100	100	10	42140	14mm	100	10
42010	10mm	55	100	10	42080	8mm	100	100	10	42160	16mm	100	10
42012	12mm	55	100	10									

### 六角 HEX BIT SOCKETS

Order No.	SIZE	55	100	10	Order No.	SIZE	55	100	10	Order No.	SIZE	100	10
40004	4mm	55	100	10	40017	17mm	55	100	10	40120	12mm	100	10
40005	5mm	55	100	10	40019	19mm	55	100	10	40140	14mm	100	10
40006	6mm	55	100	10	40040	4mm	100	100	10	40160	16mm	100	10
40007	7mm	55	100	10	40050	5mm	100	100	10	40170	17mm	100	10
40008	8mm	55	100	10	40060	6mm	100	100	10	40180	18mm	100	10
40010	10mm	55	100	10	40070	7mm	100	100	10	40190	19mm	100	10
40012	12mm	55	100	10	40080	8mm	100	100	10				
40014	14mm	55	100	10	40100	10mm	100	100	10				

Order No.	SIZE	250	10
40255	5mm	250	10
40256	6mm	250	10
40328	8mm	320	10

## 3/8 系列旋具套筒 3/8" Bit socket series



### 一字 SLOTTED BIT SOCKETS

Order No.	SIZE		
30040	4mm	48	15
30055	5.5mm	48	15
30065	6.5mm	48	15
30070	7mm	48	15
30080	8mm	48	15



### 六角 HEX BIT SOCKETS

Order No.	SIZE		
30003	3mm	48	15
30004	4mm	48	15
30005	5mm	48	15
30006	6mm	48	15
30007	7mm	48	15
30008	8mm	48	15
30010	10mm	48	15



### 十字 PHILLIPS BIT SOCKETS

Order No.	SIZE		
30371	#1	48	15
30372	#2	48	15
30373	#3	48	15



### 米字 POZI BIT SOCKETS

Order No.	SIZE		
30381	#1	48	15
30382	#2	48	15
30383	#3	48	15



### 中孔花形 TAMPER PROOF TORX BIT SOCKETS

Order No.	SIZE		
30045	T-45	48	15
30050	T-50	48	15
30055	T-55	48	15
33060	T-60	48	15



### 花形 TORX BIT SOCKETS

Order No.	SIZE		
31010	T-10	48	15
31015	T-15	48	15
31020	T-20	48	15
31025	T-25	48	15
31027	T-27	48	15
31030	T-30	48	15

Order No.	SIZE		
31040	T-40	48	15
31045	T-45	48	15
31050	T-50	48	15
31055	T-55	48	15
31060	T-60	48	15

## 1/4 系列旋具套筒 1/4" Bit socket series



### 一字 SLOTTED BIT SOCKETS

Order No.	SIZE		
20040	4mm	37	15
20055	5.5mm	37	15
20065	6.5mm	37	15



### 十字 PHILLIPS BIT SOCKETS

Order No.	SIZE		
20371	#1	37	15
20372	#2	37	15
20373	#3	37	15



### 米字 POZI BIT SOCKETS

Order No.	SIZE		
20381	#1	37	15
20382	#2	37	15
20383	#3	37	15



### 花形 TORX BIT SOCKETS

Order No.	SIZE		
21008	T-8	37	15
21010	T-10	37	15
21015	T-15	37	15
21020	T-20	37	15

Order No.	SIZE		
21025	T-25	37	15
21030	T-30	37	15
21040	T-40	37	15



### 六角 HEX BIT SOCKETS

Order No.	SIZE		
20003	3mm	37	15
20004	4mm	37	15
20005	5mm	37	15
20006	6mm	37	15
20007	7mm	37	15
20008	8mm	37	15





## 双头批咀系列 Double end screwdriver bits series

⊕ 十字双头批咀 phillips Double End Bits

Order No. D(#) B(mm) L(mm) PC/CTN NW/GW(kg)

PH02050	0"	6.35	50	1000	15/16
PH12050	1"	6.35	50	1000	15/16
PH22050	2"	6.35	50	1000	15/16
PH32050	3"	6.35	50	1000	15/16
PH12065	1"	6.35	65	1000	17/18
PH22065	2"	6.35	65	1000	17/18
PH32065	3"	6.35	65	1000	17/18
PH22065S	2"	φ6.0	65	1000	17/18
PH12075	1"	6.35	75	1000	20/21
PH22075	2"	6.35	75	1000	20/21
PH32075	3"	6.35	75	1000	18/19
PH120100	1"	6.35	100	500	16/17
PH220100	2"	6.35	100	500	16/17
PH320100	3"	6.35	100	500	16/17
PH120125	1"	6.35	125	800	21/22
PH220125	2"	6.35	125	800	21/22
PH320125	3"	6.35	125	800	21/22
PH120150	1"	6.35	150	500	22/23
PH220150	2"	6.35	150	500	22/23
PH320150	3"	6.35	150	500	22/23
PH120200	1"	6.35	200	500	27/28
PH220200	2"	6.35	200	500	27/28
PH120250	1"	6.35	250	400	29/30
PH220250	2"	6.35	250	400	29/30
PH120300	1"	6.35	300	300	25/26
PH220300	2"	6.35	300	300	25/26

⊕ 米字双头批咀 Pozidriv Double End Bits

Order No. D(#) B(mm) L(mm) PC/CTN NW/GW(kg)

PZ12050	1"	6.35	50	1000	15/16
PZ22050	2"	6.35	50	1000	15/16
PZ32050	3"	6.35	50	1000	15/16
PZ12065	1"	6.35	65	1000	17/18
PZ22065	2"	6.35	65	1000	17/18
PZ32065	3"	6.35	65	1000	17/18
PZ22065S	2"	φ6.0	65	1000	17/18

## 25mm 单头批咀系列 25mm single end screwdriver bits series

⊙ 六角形批咀 Hexagonal Bits

Order No. D(#) B(mm) L(mm) PC/CTN NW/GW(kg)

H1525	1.5	6.35	25	2000	13/14
H2025	2.0	6.35	25	2000	13/14
H2525	2.5	6.35	25	2000	13/14
H3025	3.0	6.35	25	2000	14/15
H4025	4.0	6.35	25	2000	14/15
H5024	5.0	6.35	25	2000	15/16
H5525	5.5	6.35	25	2000	15/16
H6025	6.0	6.35	25	2000	16/17
H6325	6.35	6.35	25	2000	16/17
H7025	7.0	6.35	25	2000	16/17
H8025	8.0	6.35	25	2000	17/18
H11625	1/16	6.35	25	2000	13/14
H56425	5/64	6.35	25	2000	13/14
H33225	3/32	6.35	25	2000	13/14
H76423	7/64	6.35	25	2000	14/15
H1825	1/8	6.35	25	2000	14/15
H96425	9/64	6.35	25	2000	15/16
H53225	5/32	6.35	25	2000	15/16
H31625	3/16	6.35	25	2000	16/17
H73225	7/32	6.35	25	2000	16/17
H1425	1/4	6.35	25	2000	16/17

## 25mm单头批咀系列 25mm single end screwdriver bits series

⊖ 一字形批咀 Slotted Bits

Order No. D(#) B(mm) L(mm) PC/CTN NW/GW(kg)

SL2525	2.5	6.35	25	2000	15/16
SL3025	3.0	6.35	25	2000	15/16
SL4025	4.0	6.35	25	2000	15/16
SL4525	4.5	6.35	25	2000	15/16
SL5025	5.0	6.35	25	2000	15/16
SL5525	5.5	6.35	25	2000	15/16
SL6025	6.0	6.35	25	2000	15/16
SL7025	7.0	6.35	25	2000	15/16

⊕ 米字形批咀 Pozidriv Bits

Order No. D(#) B(mm) L(mm) PC/CTN NW/GW(kg)

PZ025	0"	6.35	25	2000	15/16
PZ125	1"	6.35	25	2000	15/16
PZ225	2"	6.35	25	2000	15/16
PZ325	3"	6.35	25	2000	15/16

⊙ 菊花形批咀 Torx Bits

Order No. D(#) B(mm) L(mm) PC/CTN NW/GW(kg)

T625	T6	6.35	25	2000	15/16
T725	T7	6.35	25	2000	15/16
T825	T8	6.35	25	2000	15/16
T925	T9	6.35	25	2000	15/16
T1025	T10	6.35	25	2000	15/16
T1525	T15	6.35	25	2000	15/16
T2025	T20	6.35	25	2000	15/16
T2525	T25	6.35	25	2000	15/16
T2725	T27	6.35	25	2000	15/16
T3025	T30	6.35	25	2000	15/16
T3525	T35	6.35	25	2000	15/16
T4025	T40	6.35	25	2000	15/16
T4525	T45	6.35	25	2000	15/16

⊙ 六角星孔批咀 Hex Bits with hole

Order No. D(#) B(mm) L(mm) PC/CTN NW/GW(kg)

HX1525	1.5	6.35	25	2000	13/14
HX2025	2.0	6.35	25	2000	13/14
HX2525	2.5	6.35	25	2000	13/14
HX3025	3.0	6.35	25	2000	14/15
HX4025	4.0	6.35	25	2000	14/15
HX5024	5.0	6.35	25	2000	15/16
HX5525	5.5	6.35	25	2000	15/16
HX6025	6.0	6.35	25	2000	16/17
HX6325	6.35	6.35	25	2000	16/17
HX7025	7.0	6.35	25	2000	16/17
HX8025	8.0	6.35	25	2000	17/18
HX11625	1/16	6.35	25	2000	13/14
HX56425	5/64	6.35	25	2000	13/14
HX33225	3/32	6.35	25	2000	13/14
HX76423	7/64	6.35	25	2000	14/15
HX1825	1/8	6.35	25	2000	14/15
HX96425	9/64	6.35	25	2000	15/16
HX53225	5/32	6.35	25	2000	15/16
HX31625	3/16	6.35	25	2000	16/17
HX73225	7/32	6.35	25	2000	16/17
Hx1425	1/4	6.35	25	2000	16/17

## 转向接杆系列 EXTENSION BAR SERIES

1/4" ,3/8" ,1/2" DR.,EXTENSION BARS



Order No.	F/inch	M/inch	D2/mm	L/mm
811020	1/4	1/4	12	50
811075	1/4	1/4	12	75
811100	1/4	1/4	12	100
811150	1/4	1/4	12	150
812075	3/8	3/8	17.7	75
812150	3/8	3/8	17.7	150
812250	3/8	3/8	17.7	250
813075	1/2	1/2	24	75
813125	1/2	1/2	24	125
813250	1/2	1/2	24	250

## 三用接头系列 3 WITH THE CONNECTOR SERIES

3/8" ,1/2" DR.,3-WAY T-BAR ADAPTOR



Order No.	F/inch	M/inch	L/mm
822010	3/8	1/4	27
822030	3/8	1/2	37.5
823020	1/2	3/8	34
823040	1/2	3/4	50

## 万向接头系列 UNIVERSAL JOINT SERIES

1/4" ,3/8" ,1/2" DR.,UNIVERSAL JOINTS



Order No.	F/inch	M/inch	L/mm
831001	1/4	1/4	40
832001	3/8	3/8	56
833001	1/2	1/2	75

## 转换头系列 ADAPTER SERIES

3/8" ,1/2" DR.,ADAPTERS



Order No.	F/inch	M/inch	L/mm
822010	3/8	1/4	27
822030	3/8	1/2	37.5
823020	1/2	3/8	34
823040	1/2	3/4	50

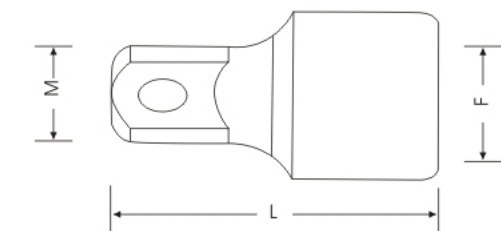

## 滑行杆

SLIDING" T" HANDLES



Order No.	S/inch	L/mm	Type
61115	1/4	115	★
612165	3/8	165	★
613250	1/2	250	★
613300	1/2	300	★

